

Features

- Peak pulse power: 1500 W (10/1000 μ s)
- Breakdown voltage range:
From 6.8 V to 440 V
- Uni and bidirectional types
- Low clamping factor
- Fast response time
- UL 497B file number: QVGQ2.E136224

Description

Transil diodes provide high overvoltage protection by clamping action. Their instantaneous response to transient overvoltages makes them particularly suited to protect voltage sensitive devices such as MOS Technology and low voltage supplied IC's.

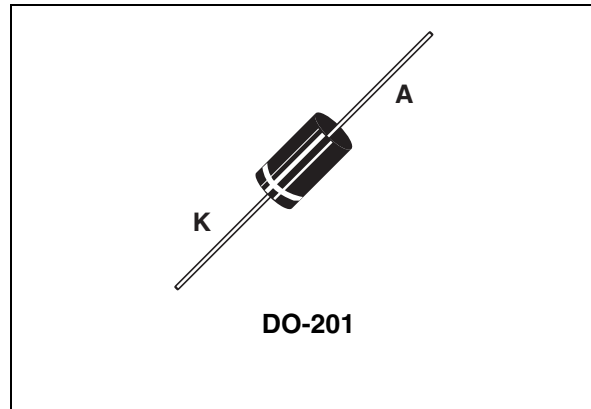

TM:Transil is a trademarks of STMicroelectronics.

1 Characteristics

Table 1. Absolute maximum ratings ($T_{amb} = 25\text{ }^\circ\text{C}$)

Symbol	Parameter	Value	Unit
P_{PP}	Peak pulse power dissipation ⁽¹⁾	$T_{j\text{ initial}} = T_{amb}$ 1500	W
P	Power dissipation on infinite heatsink	$T_{amb} = 75\text{ }^\circ\text{C}$ 5	W
I_{FSM}	Non repetitive surge peak forward current for unidirectional types	$t_p = 10\text{ ms}$ $T_{j\text{ initial}} = T_{amb}$ 200	A
T_{stg}	Storage temperature range	-65 to + 175	$^\circ\text{C}$
T_j	Maximum operating junction temperature	175	$^\circ\text{C}$
T_L	Maximum lead temperature for soldering during 10s at 5mm from case.	230	$^\circ\text{C}$

1. For a surge greater than the maximum values, the diode will fail in short-circuit.

Table 2. Thermal parameter

Symbol	Parameter	Value	Unit
$R_{th(j-l)}$	Junction to leads	20	$^\circ\text{C/W}$
$R_{th(j-a)}$	Junction to ambient on printed circuit. $L_{lead} = 10\text{ mm}$	75	

Figure 1. Electrical characteristics - definitions

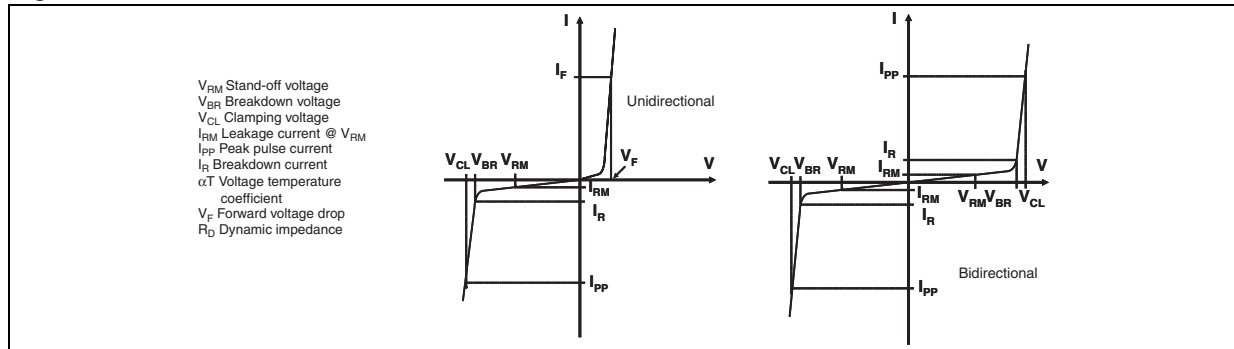

Table 3. Electrical characteristics - parameter values ($T_{amb} = 25\text{ }^{\circ}\text{C}$)

Order code	I_{RM} @ V_{RM}		V_{BR} @ $I_R^{(1)}$				V_{CL} @ I_{PP} 10/1000 μs		V_{CL} @ I_{PP} 8/20 μs		$\alpha T^{(2)}$	$C^{(3)}$
	max.		max.	nom.	min.	max.		max.		max.	typ.	
	μA	V	V	V	V	mA	V	A	V	A	10-4/ $^{\circ}\text{C}$	pF
1.5KE6V8A/CA	1000	5.8	6.45	6.8	7.14	10	10.5	143	13.4	746	5.7	9500
1.5KE7V5A/CA	500	6.4	7.13	7.5	7.88	10	11.3	132	14.5	690	6.1	8500
1.5KE10A/CA	10	8.55	9.5	10	10.5	1	14.5	100	18.6	538	7.3	7000
1.5KE12A/CA	5	10.2	11.4	12	12.6	1	16.7	90	21.7	461	7.8	6000
1.5KE15A/CA	1	12.8	14.3	15	15.8	1	21.2	71	27.2	368	8.4	5000
1.5KE18A/CA	1	15.3	17.1	18	18.9	1	25.2	59.5	32.5	308	8.8	4300
1.5KE22A/CA	1	18.8	20.9	22	23.1	1	30.6	49	39.3	254	9.2	3700
1.5KE24A/CA	1	20.5	22.8	24	25.2	1	33.2	45	42.8	234	9.4	3500
1.5KE27A/CA	1	23.1	25.7	27	28.4	1	37.5	40	48.3	207	9.6	3200
1.5KE30A/CA	1	25.6	28.5	30	31.5	1	41.5	36	53.5	187	9.7	2900
1.5KE33A/CA	1	28.2	31.4	33	34.7	1	45.7	33	59.0	169	9.8	2700
1.5KE36A/CA	1	30.8	34.2	36	37.8	1	49.9	30	64.3	156	9.9	2500
1.5KE39A/CA	1	33.3	37.1	39	41.0	1	53.9	28	69.7	143	10.0	2400
1.5KE47A/CA	1	40.2	44.7	47	49.4	1	64.8	23.2	84	119	10.1	2050
1.5KE56A/CA	1	47.8	53.2	56	58.8	1	77	19.5	100	100	10.3	1800
1.5KE62A/CA	1	53.0	58.9	62	65.1	1	85	17.7	111	90	10.4	1700
1.5KE68A/CA	1	58.1	64.6	68	71.4	1	92	16.3	121	83	10.4	1550
1.5KE82A/CA	1	70.1	77.9	82	86.1	1	113	13.3	146	69	10.5	1350
1.5KE100A/CA	1	85.5	95.0	100	105	1	137	11	178	56	10.6	1150
1.5KE120A/CA	1	102	114	120	126	1	165	9.1	212	47	10.7	1000
1.5KE150A/CA	1	128	143	150	158	1	207	7.2	265	38	10.8	850
1.5KE180A/CA	1	154	171	180	189	1	246	6.1	317	31.5	10.8	725
1.5KE200A/CA	1	171	190	200	210	1	274	5.5	353	28	10.8	675
1.5KE220A/CA	1	188	209	220	231	1	328	4.6	388	26	10.8	625
1.5KE250A/CA	1	213	237	250	263	1	344	5.0	442	23	11	560
1.5KE300A/CA	1	256	285	300	315	1	414	5.0	529	19	11	500
1.5KE350A/CA	1	299	332	350	368	1	482	4.0	618	16	11	430
1.5KE400A/CA	1	342	380	400	420	1	548	4.0	706	14	11	390
1.5KE440A/CA	1	376	418	440	462	1	603	3.5	776	13	11	360

1. Pulse test: $t_p < 50\text{ ms}$ (see [Figure 2](#))

2. $\Delta V_{BR} = \alpha T \times (T_{amb} - 25) \times V_{BR}(25\text{ }^{\circ}\text{C})$

3. $V_R = 0\text{ V}$, $F = 1\text{ MHz}$. For bidirectional types, capacitance value is divided by 2.

Figure 2. Pulse definition for electrical characteristics

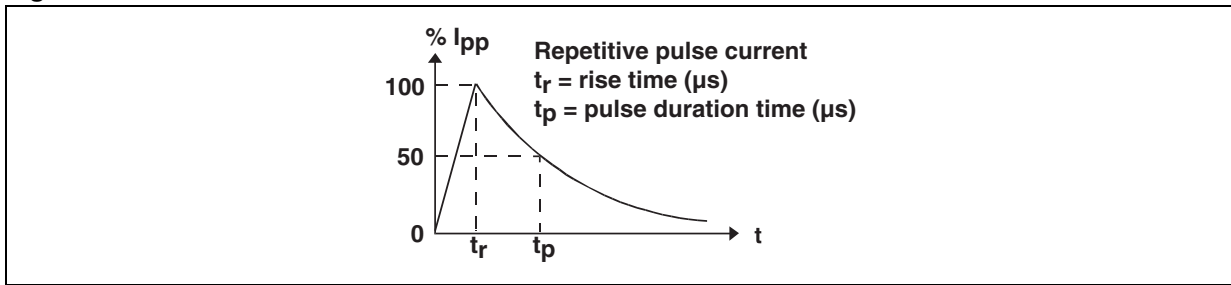

Figure 3. Peak pulse power dissipation versus initial junction temperature (printed circuit board)

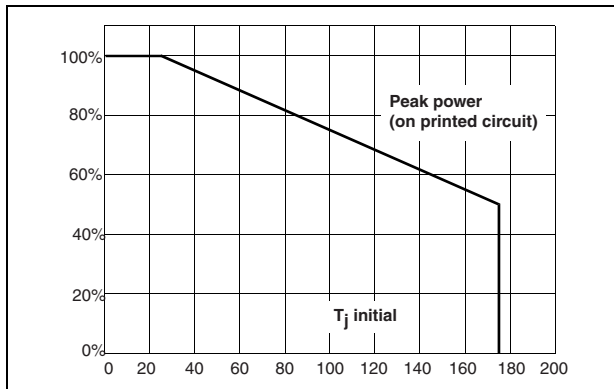

Figure 4. Peak pulse power versus exponential pulse duration

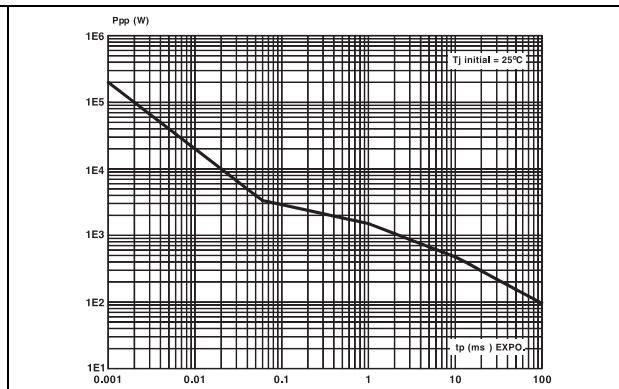

Figure 5. Clamping voltage versus peak pulse current

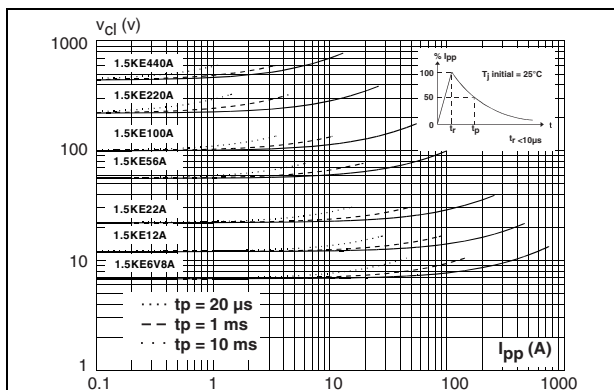
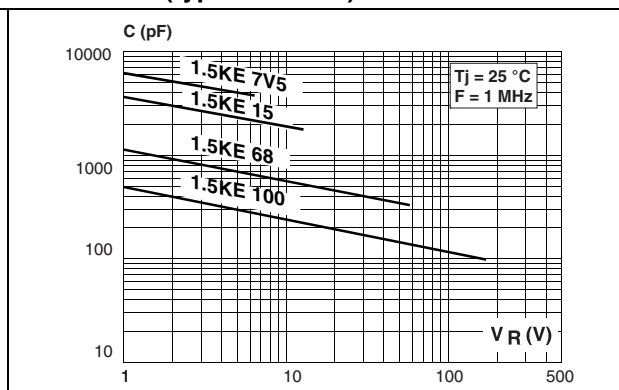

Figure 6. Capacitance versus reverse applied voltage for unidirectional types (typical values)



The curves of [Figure 5](#) are specified for a junction temperature of 25 °C before surge. The given results may be extrapolated for other junction temperatures by using the following formula:

$$\Delta V_{BR} = \alpha T \times (T_{amb} - 25) \times V_{BR} (25 \text{ } ^\circ\text{C}).$$

For intermediate voltages, extrapolate the given results.

Figure 7. Capacitance versus reverse applied voltage for bidirectional types (typical values)

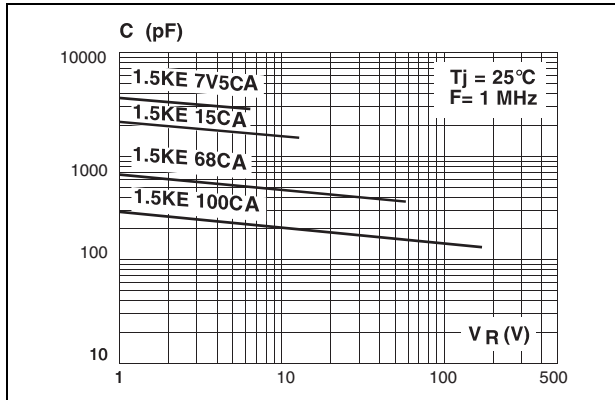

Figure 8. Peak forward voltage drop versus peak forward current (typical values for unidirectional types)

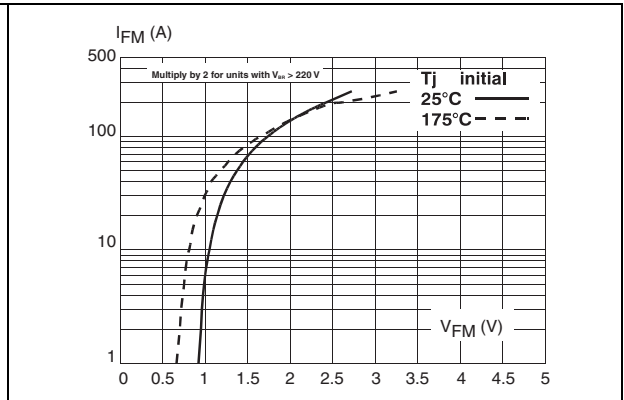

Figure 9. Transient thermal impedance junction-ambient versus pulse duration

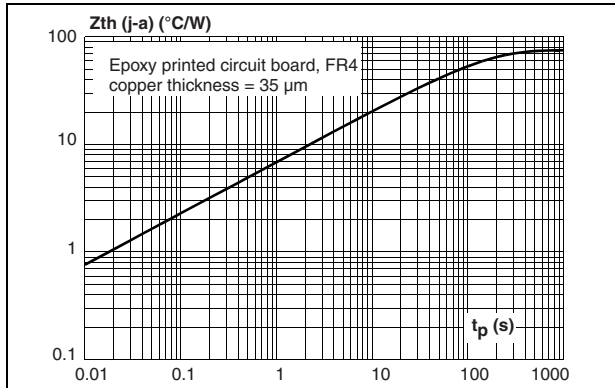
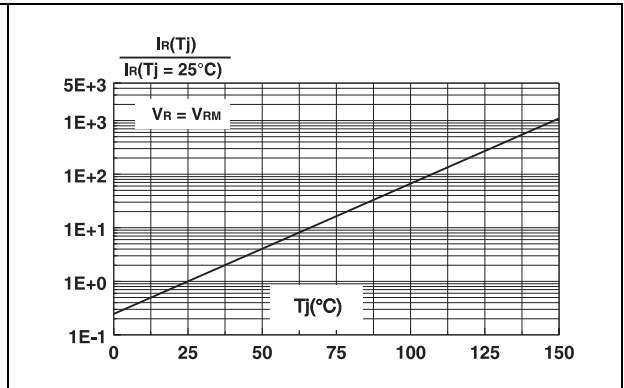
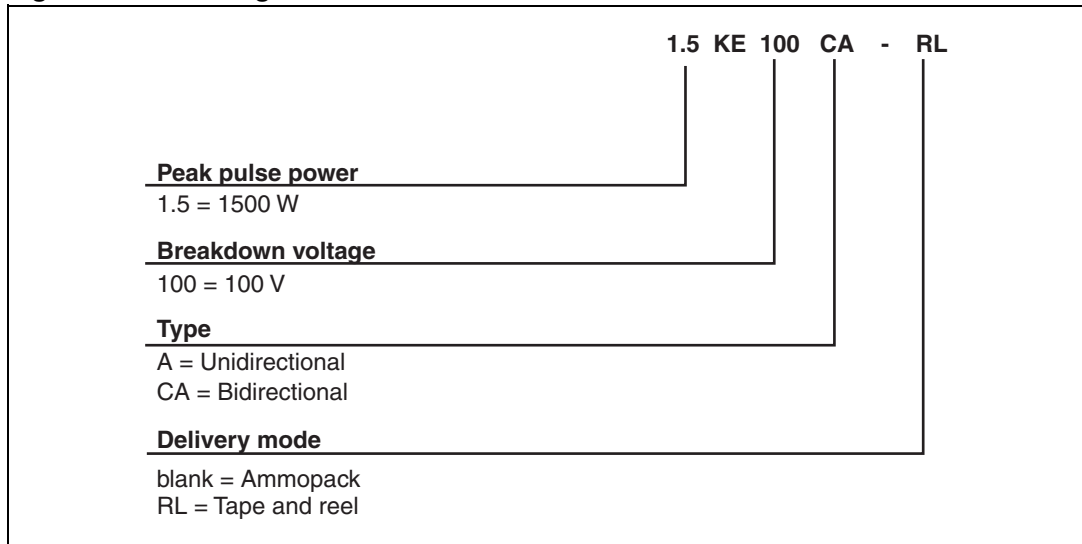

Figure 10. Relative variation of leakage current versus junction temperature



2 Ordering information scheme

Figure 11. Ordering information scheme



3 Package information

- Epoxy meets UL94, V0
- Lead-free package

In order to meet environmental requirements, ST offers these devices in different grades of ECOPACK[®] packages, depending on their level of environmental compliance. ECOPACK[®] specifications, grade definitions and product status are available at: www.st.com. ECOPACK[®] is an ST trademark.

Table 4. DO-201 dimensions

Ref.	dimensions			
	Millimeters		Inches	
	Min.	Max.	Min.	Max.
A	8.5	9.5	0.335	0.374
B	25.4		1	
Ø C	4.8	5.3	0.189	0.209
Ø D	0.96	1.06	0.038	0.042

Table 5. Marking

Order code	Marking ⁽¹⁾		Order code	Marking ⁽¹⁾	
1.5KE6V8A	1.5KE 6V8A	1.5KE6V8A	1.5KE6V8CA	1.5KE 6V8CA	1.5KE6V8CA
1.5KE7V5A	1.5KE 7V5A	1.5KE7V5A	1.5KE7V5CA	1.5KE 7V5CA	1.5KE7V5CA5
1.5KE10A	1.5KE 10A	1.5KE10A	1.5KE10CA	1.5KE 10CA	1.5KE10CA
1.5KE12A	1.5KE 12A	1.5KE12A	1.5KE12CA	1.5KE 12CA	1.5KE12CA
1.5KE15A	1.5KE 15A	1.5KE15A	1.5KE15CA	1.5KE 15CA	1.5KE15CA
1.5KE18A	1.5KE 18A	1.5KE18A	1.5KE18CA	1.5KE 18CA	1.5KE18CA
1.5KE22A	1.5KE 22A	1.5KE22A	1.5KE22CA	1.5KE 22CA	1.5KE22CA
1.5KE24A	1.5KE 24A	1.5KE24A	1.5KE24CA	1.5KE 24CA	1.5KE24CA
1.5KE27A	1.5KE 27A	1.5KE27A	1.5KE27CA	1.5KE 27CA	1.5KE27CA
1.5KE30A	1.5KE 30A	1.5KE30A	1.5KE30CA	1.5KE 30CA	1.5KE30CA
1.5KE33A	1.5KE 33A	1.5KE33A	1.5KE33CA	1.5KE 33CA	1.5KE33CA
1.5KE36A	1.5KE 36A	1.5KE36A	1.5KE36CA	1.5KE 36CA	1.5KE36CA
1.5KE39A	1.5KE 39A	1.5KE39A	1.5KE39CA	1.5KE 39CA	1.5KE39CA
1.5KE47A	1.5KE 47A	1.5KE47A	1.5KE47CA	1.5KE 47CA	1.5KE47CA
1.5KE56A	1.5KE 56A	1.5KE56A	1.5KE56CA	1.5KE 56CA	1.5KE56CA
1.5KE62A	1.5KE 62A	1.5KE62A	1.5KE62CA	1.5KE 62CA	1.5KE62CA
1.5KE68A	1.5KE 68A	1.5KE68A	1.5KE68CA	1.5KE 68CA	1.5KE68CA
1.5KE82A	1.5KE 82A	1.5KE82A	1.5KE82CA	1.5KE 82CA	1.5KE82CA
1.5KE100A	1.5KE 100A	1.5KE100A	1.5KE100CA	1.5KE 100CA	1.5KE100CA
1.5KE120A	1.5KE 120A	1.5KE120A	1.5KE120CA	1.5KE 120CA	1.5KE120CA
1.5KE150A	1.5KE 150A	1.5KE150A	1.5KE150CA	1.5KE 150CA	1.5KE150CA
1.5KE180A	1.5KE 180A	1.5KE180A	1.5KE180CA	1.5KE 180CA	1.5KE180CA
1.5KE200A	1.5KE 200A	1.5KE200A	1.5KE200CA	1.5KE 200CA	1.5KE200CA
1.5KE220A	1.5KE 220A	1.5KE220A	1.5KE220CA	1.5KE 220CA	1.5KE220CA
1.5KE250A	1.5KE 250A	1.5KE250A	1.5KE250CA	1.5KE 250CA	1.5KE250CA
1.5KE300A	1.5KE 300A	1.5KE300A	1.5KE300CA	1.5KE 300CA	1.5KE300CA
1.5KE350A	1.5KE 350A	1.5KE350A	1.5KE350CA	1.5KE 350CA	1.5KE350CA
1.5KE400A	1.5KE 400A	1.5KE400A	1.5KE400CA	1.5KE 400CA	1.5KE400CA
1.5KE440A	1.5KE 440A	1.5KE440A	1.5KE440CA	1.5KE 440CA	1.5KE440CA

1. Marking with space is used to differentiate assembly location.

4 Ordering information

Table 6. Order codes

Order code	Marking	Package	Weight	Base qty	Delivery mode
1.5KExxxA/CA ⁽¹⁾	See Table 5	1.5KE	0.876g	1900	Tape and reel
				600	Ammopack

1. Where xxx is nominal value of V_{BR} and A or CA indicates unidirectional or bidirectional version. See [Table 3](#) for list of available devices and their order codes

5 Revision history

Table 7. Document revision history

Date	Revision	Changes
Feb -2002	3A	Last issue
12-Mar-2012	4	Added UL statement, Table 5 and ordering information.

Please Read Carefully:

Information in this document is provided solely in connection with ST products. STMicroelectronics NV and its subsidiaries ("ST") reserve the right to make changes, corrections, modifications or improvements, to this document, and the products and services described herein at any time, without notice.

All ST products are sold pursuant to ST's terms and conditions of sale.

Purchasers are solely responsible for the choice, selection and use of the ST products and services described herein, and ST assumes no liability whatsoever relating to the choice, selection or use of the ST products and services described herein.

No license, express or implied, by estoppel or otherwise, to any intellectual property rights is granted under this document. If any part of this document refers to any third party products or services it shall not be deemed a license grant by ST for the use of such third party products or services, or any intellectual property contained therein or considered as a warranty covering the use in any manner whatsoever of such third party products or services or any intellectual property contained therein.

UNLESS OTHERWISE SET FORTH IN ST'S TERMS AND CONDITIONS OF SALE ST DISCLAIMS ANY EXPRESS OR IMPLIED WARRANTY WITH RESPECT TO THE USE AND/OR SALE OF ST PRODUCTS INCLUDING WITHOUT LIMITATION IMPLIED WARRANTIES OF MERCHANTABILITY, FITNESS FOR A PARTICULAR PURPOSE (AND THEIR EQUIVALENTS UNDER THE LAWS OF ANY JURISDICTION), OR INFRINGEMENT OF ANY PATENT, COPYRIGHT OR OTHER INTELLECTUAL PROPERTY RIGHT.

UNLESS EXPRESSLY APPROVED IN WRITING BY TWO AUTHORIZED ST REPRESENTATIVES, ST PRODUCTS ARE NOT RECOMMENDED, AUTHORIZED OR WARRANTED FOR USE IN MILITARY, AIR CRAFT, SPACE, LIFE SAVING, OR LIFE SUSTAINING APPLICATIONS, NOR IN PRODUCTS OR SYSTEMS WHERE FAILURE OR MALFUNCTION MAY RESULT IN PERSONAL INJURY, DEATH, OR SEVERE PROPERTY OR ENVIRONMENTAL DAMAGE. ST PRODUCTS WHICH ARE NOT SPECIFIED AS "AUTOMOTIVE GRADE" MAY ONLY BE USED IN AUTOMOTIVE APPLICATIONS AT USER'S OWN RISK.

Resale of ST products with provisions different from the statements and/or technical features set forth in this document shall immediately void any warranty granted by ST for the ST product or service described herein and shall not create or extend in any manner whatsoever, any liability of ST.

ST and the ST logo are trademarks or registered trademarks of ST in various countries.

Information in this document supersedes and replaces all information previously supplied.

The ST logo is a registered trademark of STMicroelectronics. All other names are the property of their respective owners.

© 2012 STMicroelectronics - All rights reserved

STMicroelectronics group of companies

Australia - Belgium - Brazil - Canada - China - Czech Republic - Finland - France - Germany - Hong Kong - India - Israel - Italy - Japan - Malaysia - Malta - Morocco - Philippines - Singapore - Spain - Sweden - Switzerland - United Kingdom - United States of America

www.st.com