



SY8009A/SY8009B

High Efficiency 1.5MHz/1MHz, 1.5A/2A Synchronous Step Down Regulator

General Description

The SY8009A and SY8009B are high-efficiency, high frequency synchronous step-down DC-DC regulator ICs capable of delivering up to 1.5A/2A output currents. The SY8009 family operate over a wide input voltage range from 3V to 5.5V and integrate main switch and synchronous switch with very low $R_{DS(ON)}$ to minimize the conduction loss.

Low output voltage ripple and small external inductor and capacitor sizes are achieved with greater than 1MHz switching frequency.

Ordering Information

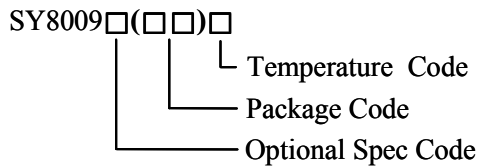

Temperature Range: -40°C to 85°C

| Ordering Number | Package type | Note ^① |
|-----------------|--------------|-------------------|
| SY8009AAAC | SOT23-5 | 1.5A |
| SY8009BABC | SOT23-6 | 2A |
| SY8009BEBC | SSOT23-6 | 2A |

Features

- Low $R_{DS(ON)}$ for internal switches (top/bottom)
 - SY8009A: 180mΩ/120mΩ, 1.5A, SOT23-5
 - SY8009B: 100mΩ/80mΩ, 2.0A SOT23-6, SSOT23-6
- 3-5.5V input voltage range
- High switching frequency minimizes the external components
 - SY8009A: 1.5MHz
 - SY8009B: 1MHz
- Internal softstart limits the inrush current
- 100% dropout operation
- RoHS Compliant and Halogen Free
- Compact package: SOT23-5, SOT23-6 and Super SOT23-6 are pin-compatible. Other packages are available upon requests

Applications

- LCD TV
- Set Top Box
- Net PC
- Mini-Notebook PC
- Access Point Router

Typical Applications

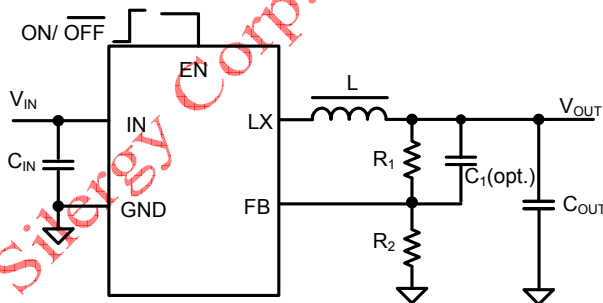

Figure 1. Schematic diagram

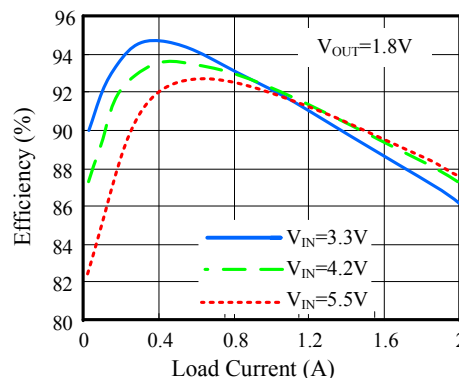
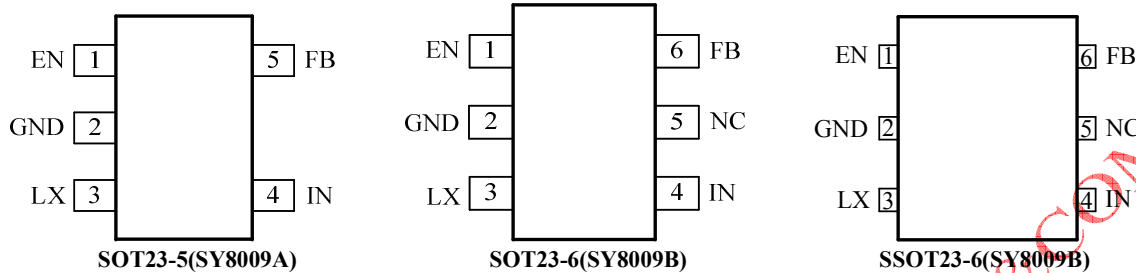

Figure 2. Efficiency vs Load Current



SY8009A/SY8009B

Pinout (top view)



| Part Number | Package type | Top Mark ^① |
|-------------|--------------|-----------------------|
| SY8009AAAC | SOT23-5 | ADxyz |
| SY8009BABC | SOT23-6 | CUxyz |
| SY8009BEBC | SSOT23-6 | ASxyz |

Note ①: x=year code, y=week code, z=lot number code.

| Pin Name | Pin Number | Pin Description |
|----------|------------|---|
| EN | 1 | Enable control. Pull high to turn on. Do not float. |
| GND | 2 | Ground pin |
| LX | 3 | Inductor pin. Connect this pin to the switching node of inductor. |
| IN | 4 | Input pin. Decouple this pin to GND pin with at least 1uF ceramic cap. |
| FB | 6 | Output Feedback Pin. Connect this pin to the center point of the output resistor divider (as shown in Figure 1) to program the output voltage: $V_{out}=0.6*(1+R_1/R_2)$ |

Absolute Maximum Ratings (Note 1)

| | |
|--|-----------------|
| Supply Input Voltage | 6.0V |
| Enable, FB Voltage | $V_{IN} + 0.6V$ |
| Power Dissipation, P_D @ $T_A = 25^\circ C$, SOT23-5, SOT23-6, SSOT23-6 | 0.6W |
| Package Thermal Resistance (Note 2) SOT23-5, SOT23-6, SSOT23-6, θ_{JA} | 170°C/W |
| SOT23-5, SOT23-6, SSOT23-6, θ_{JC} | 130°C/W |
| Junction Temperature Range | -125°C |
| Lead Temperature (Soldering, 10 sec.) | 260°C |
| Storage Temperature Range | -65°C to 150°C |
| ESD Susceptibility (Note 2) | |
| HBM (Human Body Mode) | 2kV |
| MM (Machine Mode) | 200V |
| Dynamic LX voltage in 50ns duration | IN+3V to GND-4V |

Recommended Operating Conditions (Note 3)

| | |
|----------------------------|----------------|
| Supply Input Voltage | 3V to 5.5V |
| Junction Temperature Range | -40°C to 125°C |
| Ambient Temperature Range | -40°C to 85°C |



Electrical Characteristics

($V_{IN} = 5V$, $V_{OUT} = 2.5V$, $L = 2.2\mu H$, $C_{OUT} = 10\mu F$, $T_A = 25^\circ C$, unless otherwise specified)

| Parameter | Symbol | Test Conditions | Min | Typ | Max | Unit |
|------------------------------|----------------|--|-------|-----|-------|------------|
| Input Voltage Range | V_{IN} | | 3 | | 5.5 | V |
| Quiescent Current | I_Q | $I_{OUT}=0$, $V_{FB}=V_{REF} \cdot 105\%$ | | 80 | | μA |
| Shutdown Current | I_{SHDN} | EN=0 | | 0.1 | 1 | μA |
| Feedback Reference Voltage | V_{REF} | | 0.588 | 0.6 | 0.612 | V |
| FB Input Current | I_{FB} | $V_{FB}=V_{IN}$ | -50 | | 50 | nA |
| PFET RON | $R_{DS(ON),P}$ | SY8009A | | 180 | | m Ω |
| | | SY8009B | | 100 | | m Ω |
| NFET RON | $R_{DS(ON),N}$ | SY8009A | | 120 | | m Ω |
| | | SY8009B | | 80 | | m Ω |
| PFET Current Limit | I_{LIM} | SY8009A | 1.8 | | | A |
| | | SY8009B | 2.5 | | | A |
| EN rising threshold | V_{ENH} | | 1.5 | | | V |
| EN falling threshold | V_{ENL} | | | | 0.4 | V |
| Input UVLO threshold | V_{UVLO} | | | | 2.7 | V |
| UVLO hysteresis | V_{HYS} | | | 0.1 | | V |
| Oscillator Frequency | F_{OSC} | $I_{OUT}=200mA$, SY8009A | | 1.5 | | MHz |
| | | $I_{OUT}=500mA$, SY8009B | | 1 | | MHz |
| Min ON Time | | | | 50 | | ns |
| Max Duty Cycle | | | 100 | | | % |
| Thermal Shutdown Temperature | T_{SD} | | | 160 | | $^\circ C$ |

Note 1: Stresses listed as the above “Absolute Maximum Ratings” may cause permanent damage to the device. These are for stress ratings. Functional operation of the device at these or any other conditions beyond those indicated in the operational sections of the specifications is not implied. Exposure to absolute maximum rating conditions for extended periods may remain possibility to affect device reliability.

Note 2: θ_{JA} is measured in the natural convection at $T_A = 25^\circ C$ on a low effective single layer thermal conductivity test board of JEDEC 51-3 thermal measurement standard. Pin 2 of SOT23-5/SSOT-23-6 packages is the case position for θ_{JC} measurement. Test condition: Device mounted on 2” x 2” FR-4 substrate PCB, 2oz copper, with minimum recommended pad on top layer and thermal vias to bottom layer ground plane

Note 3: The device is not guaranteed to function outside its operating conditions.

SOT23-5 Package outline & PCB layout design

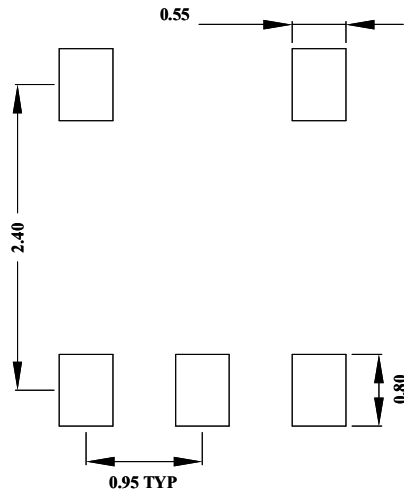

Recommended Pad Layout

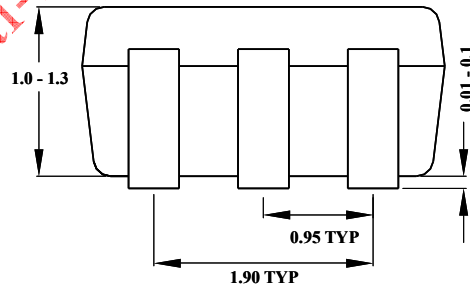
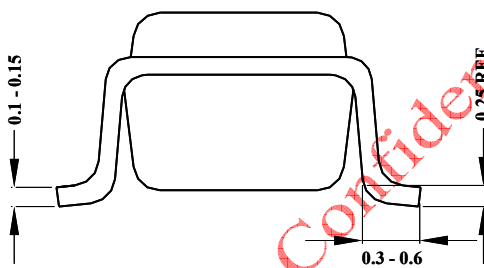
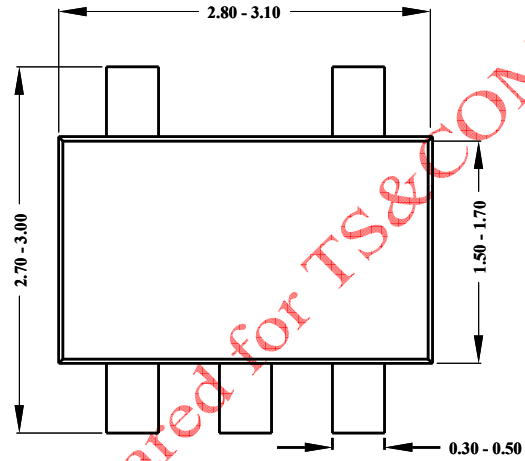

Notes: All dimensions are in millimeters.
All dimensions don't include mold flash & metal burr.

SOT23-6 Package outline & PCB layout design

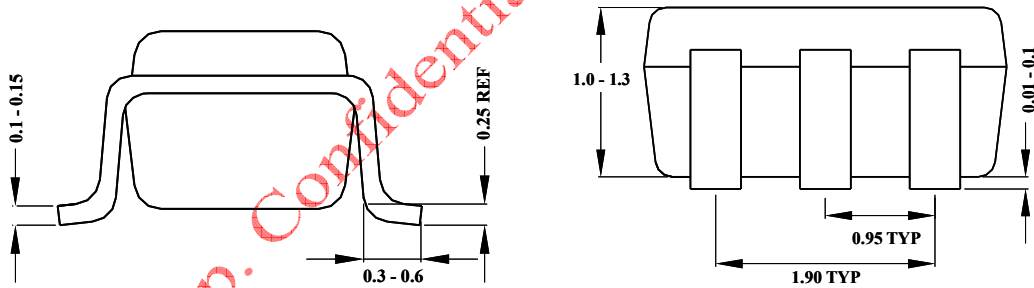
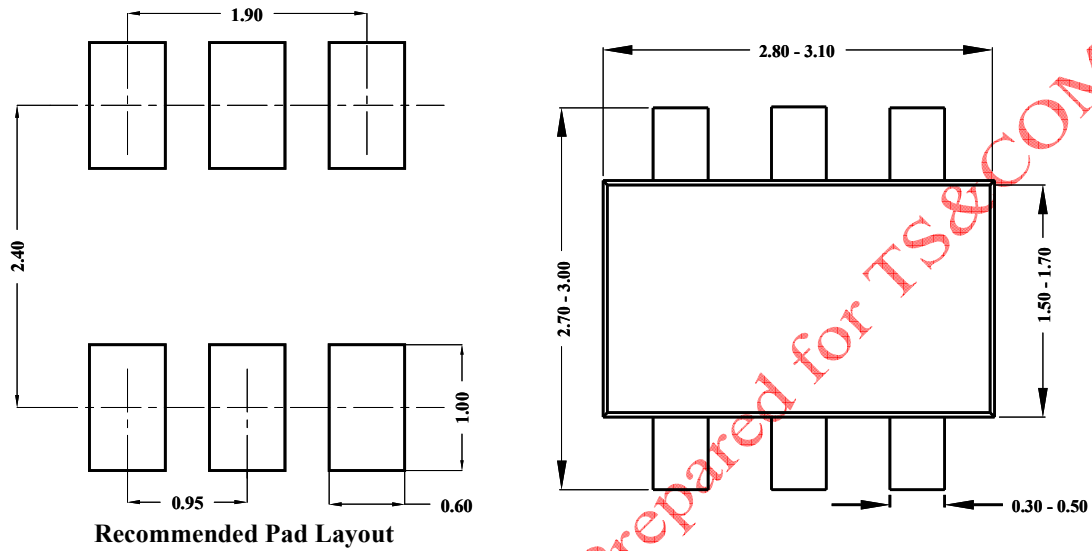

**Notes: All dimensions are in millimeters.
All dimensions don't include mold flash & metal burr.**

SSOT23-6 Package outline & PCB layout design

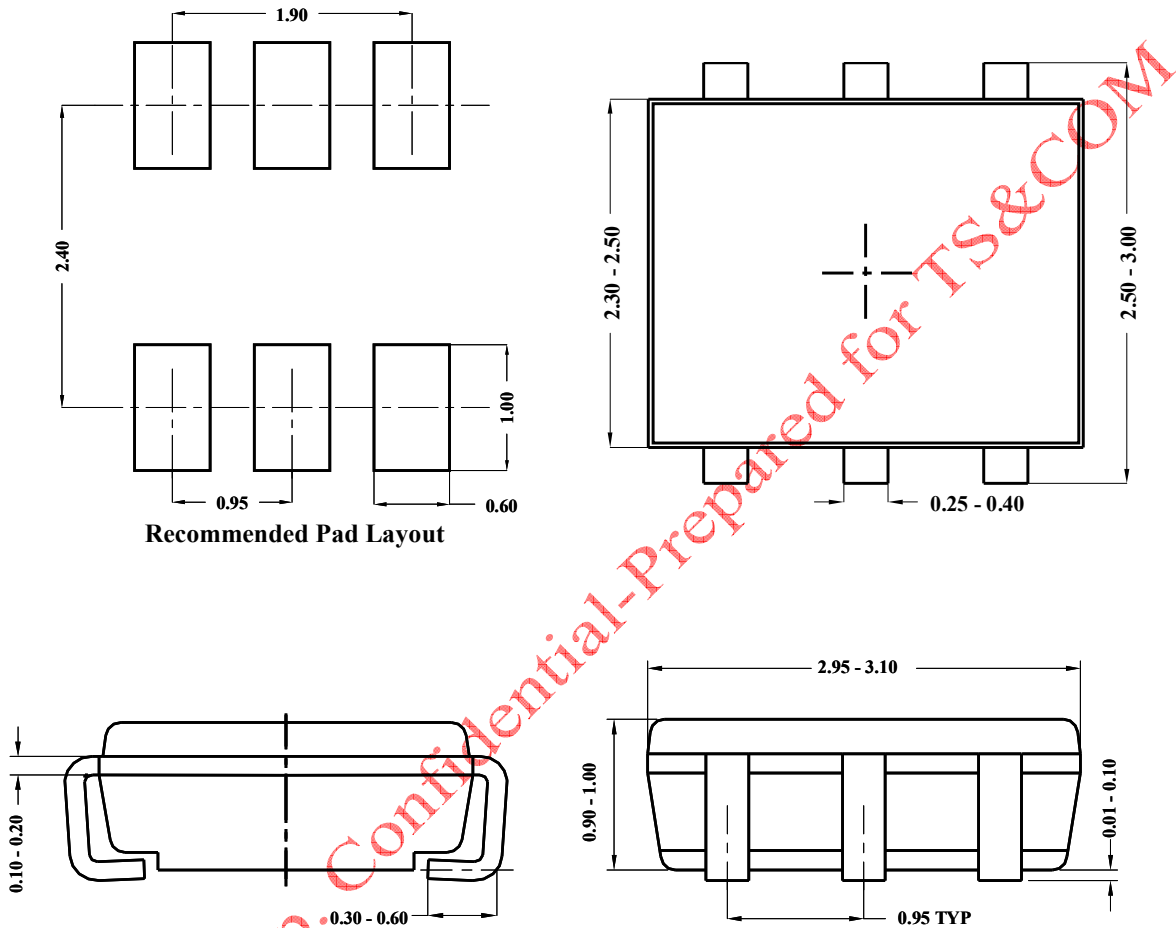

**Notes: All dimensions are in millimeters.
All dimensions don't include mold flash & metal burr.**